

Data Sheet

PRELIMINARY

SMBB1650S-1100-03

1650nm High Power TOP LED



Outline and Internal Circuit

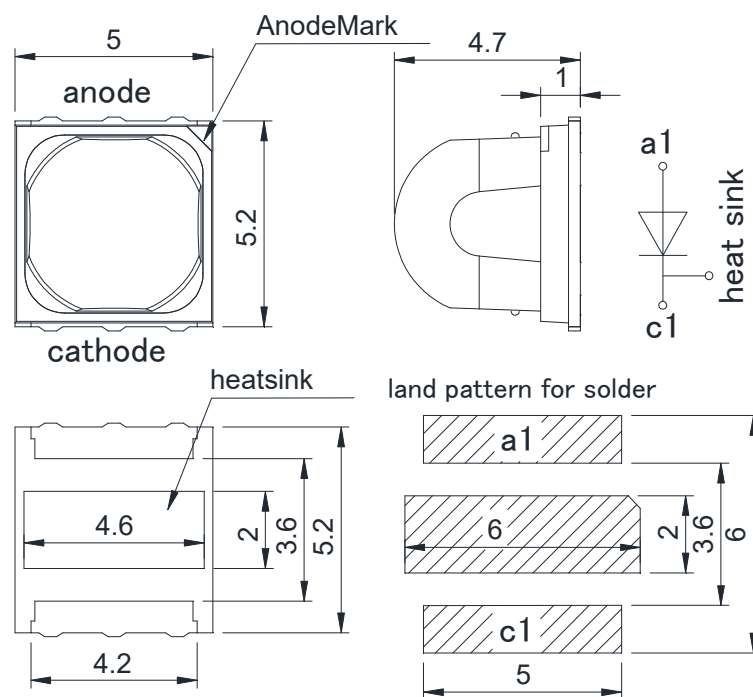

(Unit : mm)

Features

- Chip Material : InGaAsP
- Chip Dimension : 1000um * 1000um
- Number of Chips : 1pce
- Peak Wavelength : 1650nm typ.
- Lead Frame Die : Silver Plated on Copper
- Package Resin : PA9T
- Lens : Silicone Resin

Application

Absolute Maximum Ratings (Tc=25°C)

| Item | Symbol | Rated | Unit |
|-----------------------|--------|------------|------|
| Power Dissipation | PD | 900 | mW |
| Forward Current | IF | 600 | mA |
| Pulse Forward Current | IFP | 2000 | mA |
| Reverse Voltage | VR | 3 | V |
| Thermal Resistance | Rthja | 10 | K/W |
| Junction Temperature | Tj | 120 | °C |
| Operating Temperature | Topr | -40 ~ +85 | °C |
| Storage Temperature | Tstg | -40 ~ +100 | °C |
| Soldering Temperature | TSOL | 250 | °C |

‡Pulse Forward Current condition : Duty 1% and Pulse Width=10us.

‡Soldering condition : Soldering condition must be completed with 5 seconds at 250°C.

Optical and Electrical Characteristics (Tc=25°C)

| Parameter | Symbol | Min | Typ | Max | Unit | Test Condition |
|----------------------|-----------------|------|----------|------|-------|----------------|
| Forward Voltage | VF | | 1.0 | 1.5 | V | IF=500mA |
| | VFP | | 1.5 | | | IFP=2A |
| Total Radiated Power | PO | | 16 | | mW | IF=500mA |
| | | | 34 | | | IFP=2A |
| Radiant Intensity | IE | | 39 | | mW/sr | IF=500mA |
| | | | 82 | | | IFP=2A |
| Peak Wavelength | λ_p | 1600 | | 1700 | nm | IF=500mA |
| Half Width | $\Delta\lambda$ | | 120 | | nm | IF=500mA |
| Viewing Half Angle | $\theta_{1/2}$ | | ± 24 | | deg. | IF=100mA |
| Rise Time | tr | | 40 | | ns | IF=500mA |
| Fall Time | tf | | 80 | | ns | IF=500mA |

‡ Radiated Power is measured by G8370-85.

‡ Radiant Intensity is measured by ANDO Optical Multi Meter AQ2140 & AQ2743.

Typical Characteristic Curves

Forward Current - Forward Voltage

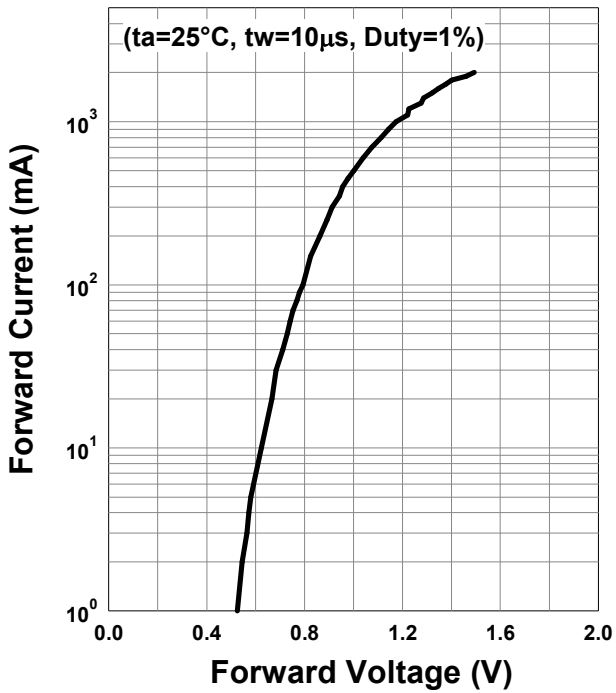

Relative Radiant Intensity - Forward Current

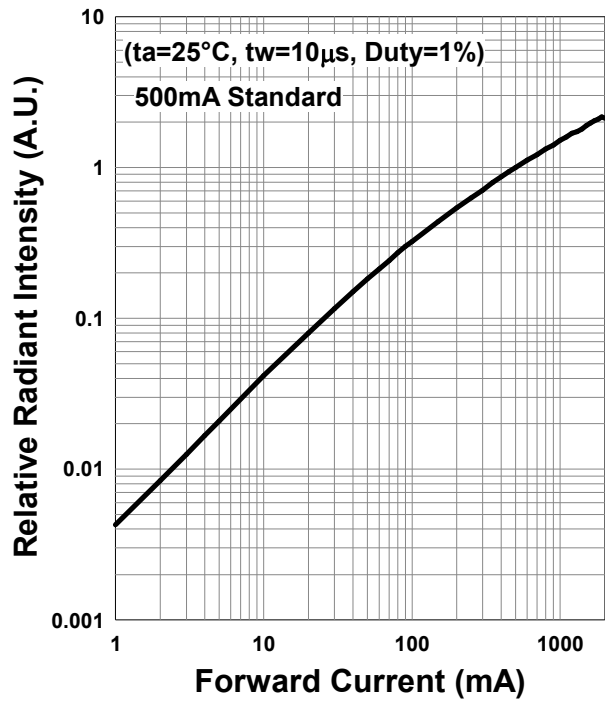

Forward Current - Pulse Duration

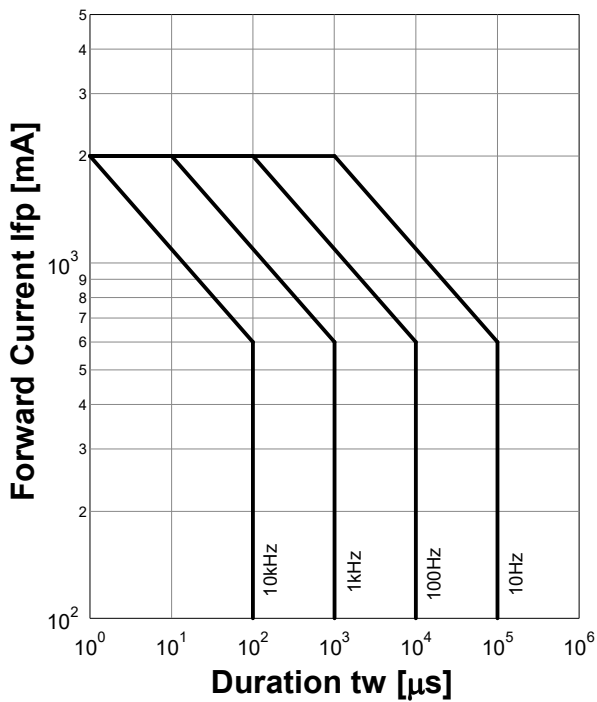

Allowable Forward Current - Ambient Temperature

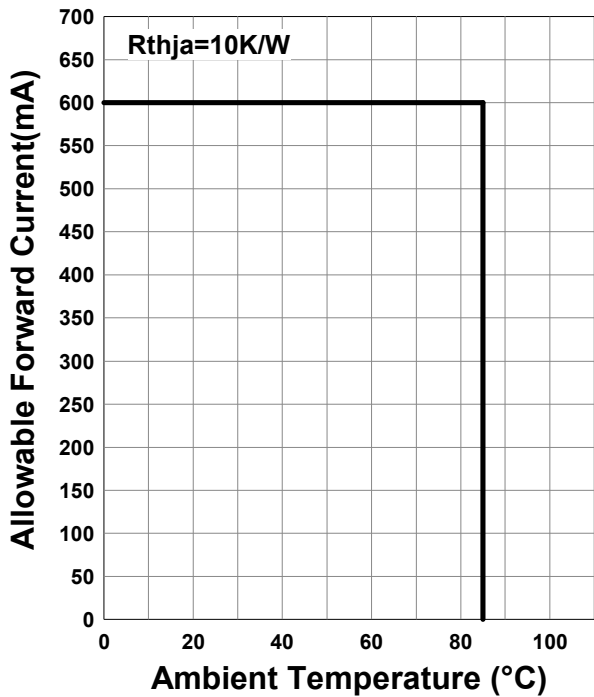

Forward Voltage - Ambient Temperature

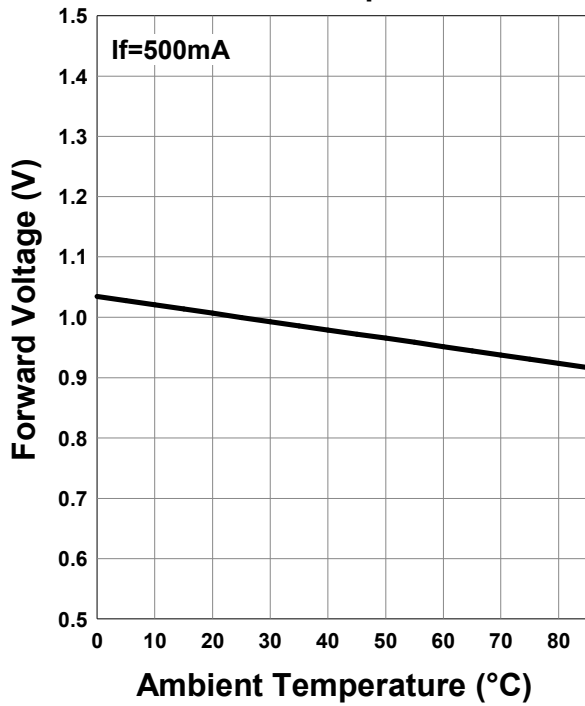

Relative Radiant Intensity - Ambient Temperature

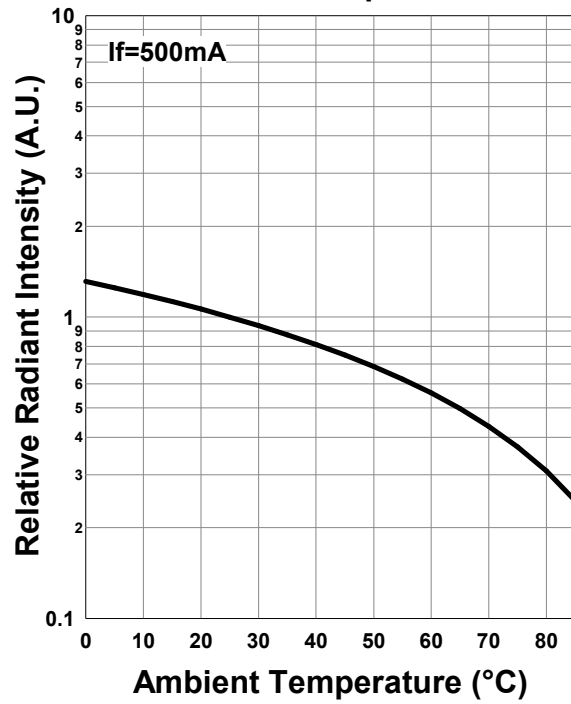

Peak Wavelength - Ambient Temperature

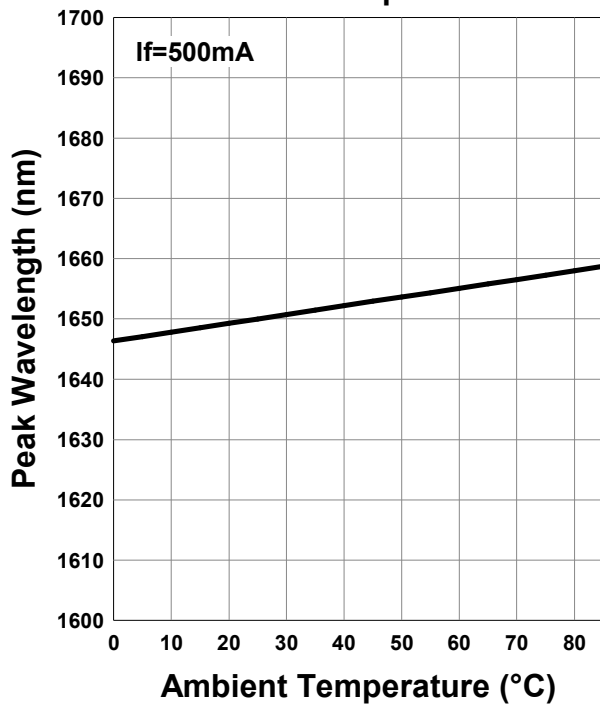

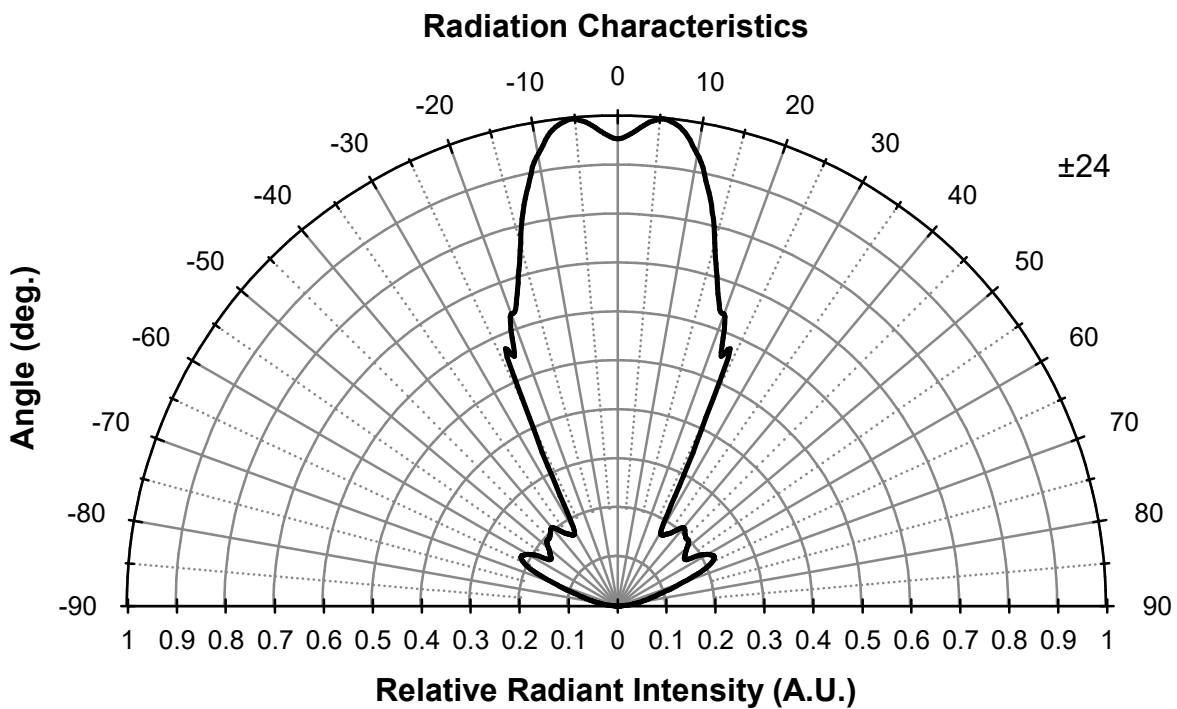
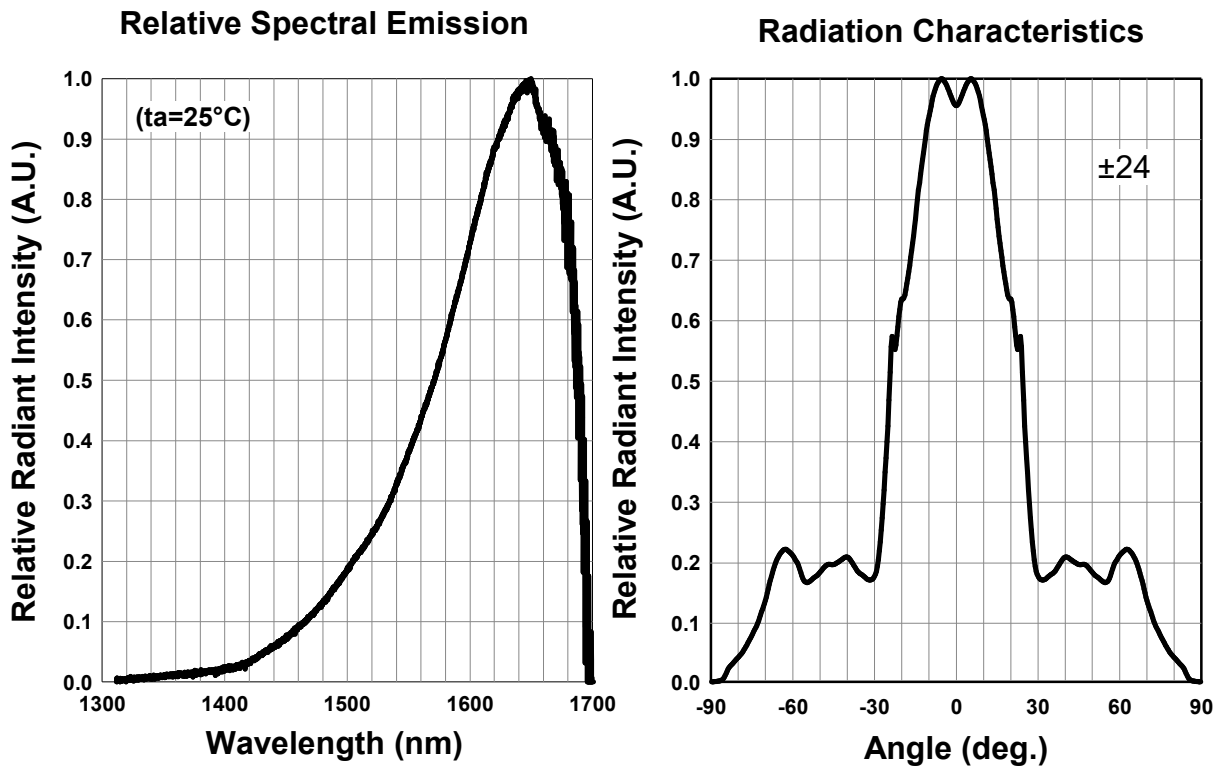

Data Sheet SMBB1650S-1100-03

Wrapping

Moisture barrier bag aluminum laminated film with a desiccant to keep out the moisture absorption during the transportation and storage.

SMD LED storage and handling precautions

Storage Conditions before Opening a Moisture-Barrier Aluminum Bag

- Before opening a moisture-barrier aluminum bag, please store it at <30°C, <60%RH.
- Please note that the maximum shelf life is 12 months under these conditions.

Storage Conditions after Opening a Moisture-Barrier Aluminum Bag

- After opening a moisture-barrier aluminum bag, store the aluminum bag and silica gel in a desiccator.
- After opening the bag, please solder the LEDs within 72 hours in a room with 5 - 30°C, <50%RH.
- Please put any unused, remaining LEDs and silica gel back in the same aluminum bag and then vacuum-seal the bag.
- It is recommended to keep the re-sealed bag in a desiccator at <30%RH.
- The 72-hour- long floor life does not include the time while LEDs are stored in the moisture-barrier aluminum bag. However, we strongly recommend to solder the LEDs as soon as possible after opening the aluminum bag

Notes about Re-sealing a Moisture-Barrier Aluminum Bag

- When vacuum-sealing an opened aluminum bag, if you find the moisture-indicator of the silica gel has changed to pink from blue (indicating a relative humidity of 30 % or more), please do not use the unused LEDs, the aluminum bag, or the silica gel.

Notes about Opening a Re-sealed Moisture-Barrier Aluminum Bag

- When opening a vacuumed and re-sealed aluminum bag in order to use the remaining LEDs stored in the bag, if you find that the moisture-indicator of the silica has changed to pink, please do not use the LEDs.

Disclaimer

Product specifications and data shown in this product catalog are subject to change without notice for the purposes of improving product performance, reliability, design, or otherwise.

Product data and parameters in this catalog are typical values based on reasonably up-to-date measurements.

Product data and parameters may vary by user application and over time.

Products shown in this catalog are intended to be used for general electronic equipment. Products are not guaranteed for applications where product malfunction or failure may cause personal injury or death, including but not limited to life-supporting / saving devices, medical devices, safety devices, airplanes, aerospace equipment, automobiles, traffic control systems, and nuclear reactor control systems.



*Effective July 2016, Ushio Epitex Inc. is now USHIO OPTO SEMICONDUCTORS, INC.