

# Data Sheet

## L940-34AU

Infrared LED Lamp

USHIO

### Outline and Internal Circuit

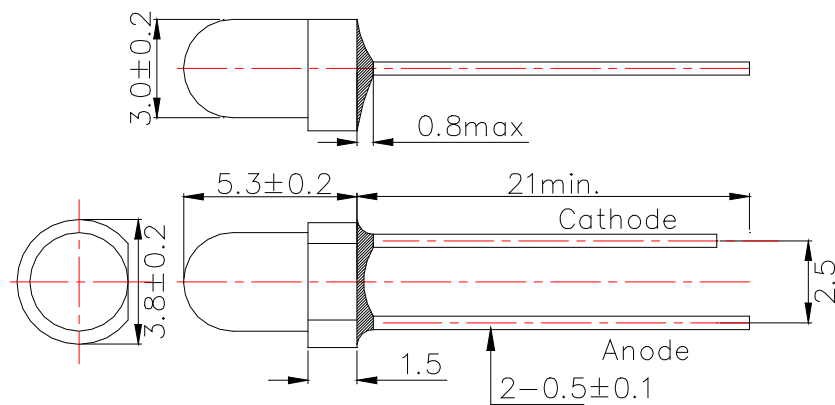

(Unit : mm)

### Features

- Chip Material : AlGaAs
- Chip Dimension :  $400 \mu\text{m} * 400 \mu\text{m}$
- Number of Chips : 1pce
- Peak Wavelength :  $940 \text{nm typ.}$
- Package Type :  $\phi 3 \text{mm}$  clear molding
- Lead Frame : Soldered (Lead Free)
- Lens : Epoxy Resin

### Application

## Absolute Maximum Ratings (Tc=25°C)

Item	Symbol	Ratings	Unit
Power Dissipation	PD	150	mW
Forward Current	IF	100	mA
Pulse Forward Current	IFP	1000	mA
Reverse Voltage	VR	5	V
Thermal Resistance	Rthja	270	K/W
Junction Temperature	Tj	120	°C
Operating Temperature	Topr	-40 ~ +100	°C
Storage Temperature	Tstg	-40 ~ +100	°C
Soldering Temperature	TSOL	265	°C

‡Pulse Forward Current condition : Duty 1% and Pulse Width=10us.

‡Soldering condition : Soldering condition must be completed with 3 seconds at 265°C.

## Optical and Electrical Characteristics (Tc=25°C)

Parameter	Symbol	Min	Typ	Max	Unit	Test Condition
Forward Voltage	VF		1.3	1.5	V	IF=50mA
	VFP		2.7			IFP=1A
Total Radiated Power	PO		15		mW	IF=50mA
			240			IFP=1A
Radiant Intensity	IE		37		mW/sr	IF=50mA
			590			IFP=1A
Peak Wavelength	$\lambda_p$	930		950	nm	IF=50mA
Half Width	$\Delta\lambda$		50		nm	IF=50mA
Viewing Half Angle	$\theta_{1/2}$		$\pm 16$		deg.	IF=50mA
Rise Time	tr		1000		ns	IF=50mA
Fall Time	tf		1000		ns	IF=50mA

‡ Radiated Power is measured by S3584-08.

‡ Radiant Intensity is measured by CIE127-2007 Condition B.

## Typical Characteristic Curves

### Forward Current - Forward Voltage

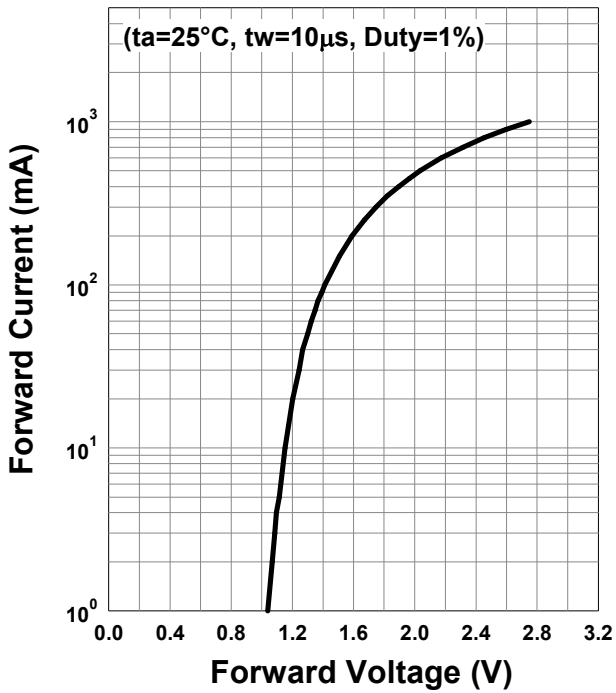

### Relative Radiant Intensity - Forward Current

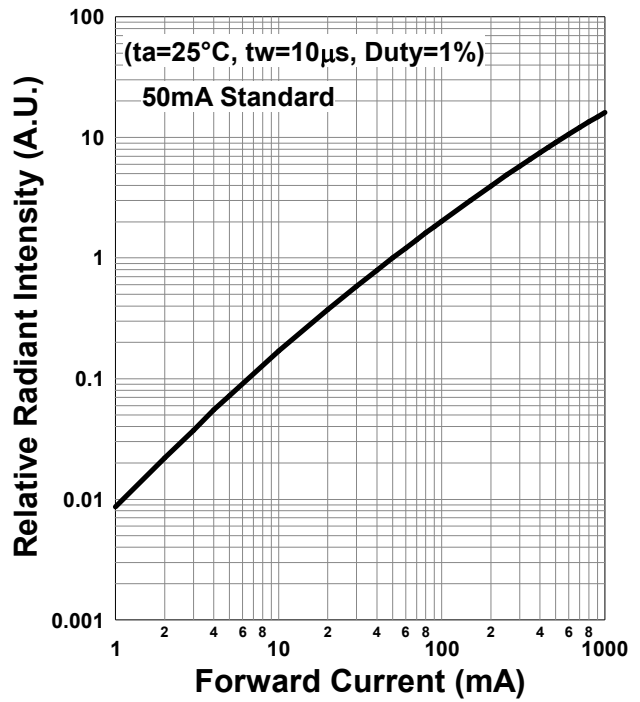

### Forward Current - Pulse Duration

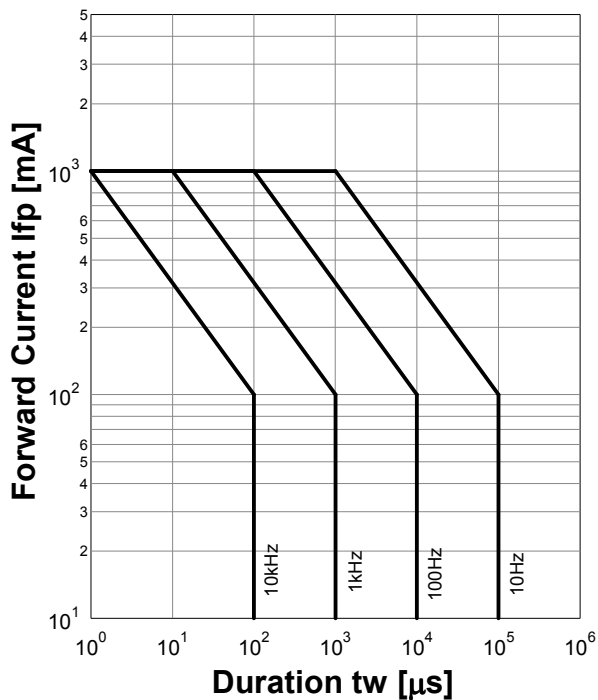

### Allowable Forward Current - Ambient Temperature

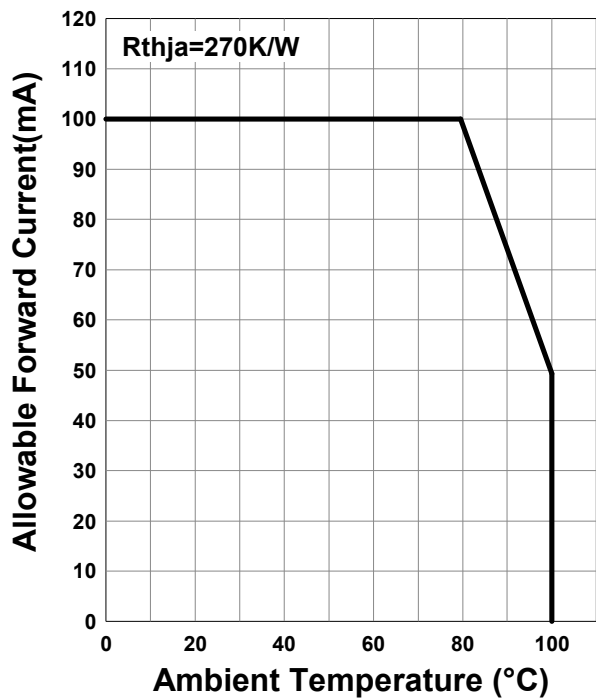

**Forward Voltage - Ambient Temperature**

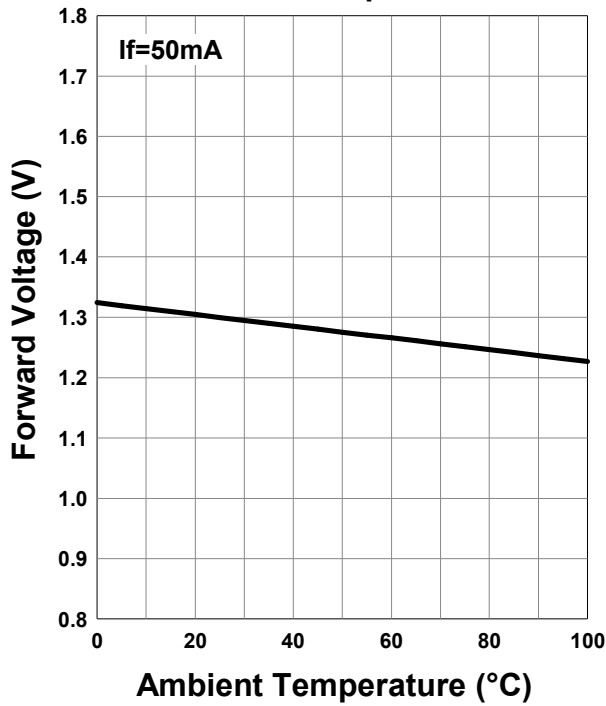

**Relative Radiant Intensity - Ambient Temperature**

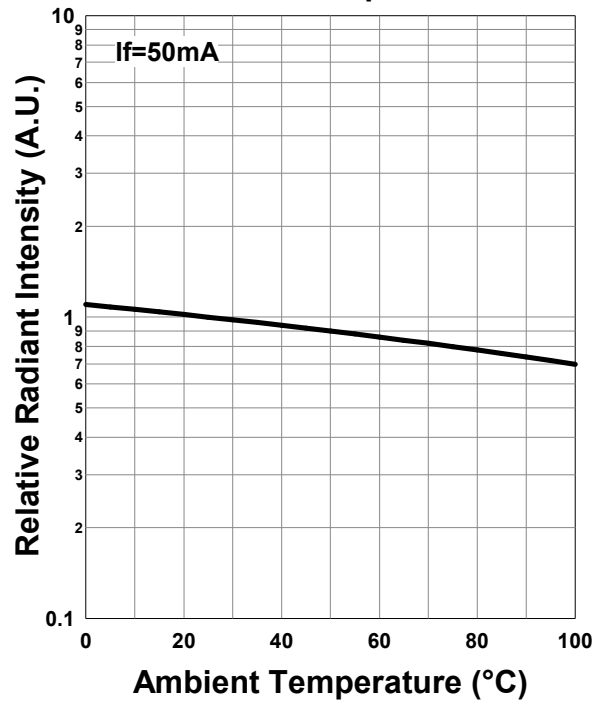

**Peak Wavelength - Ambient Temperature**

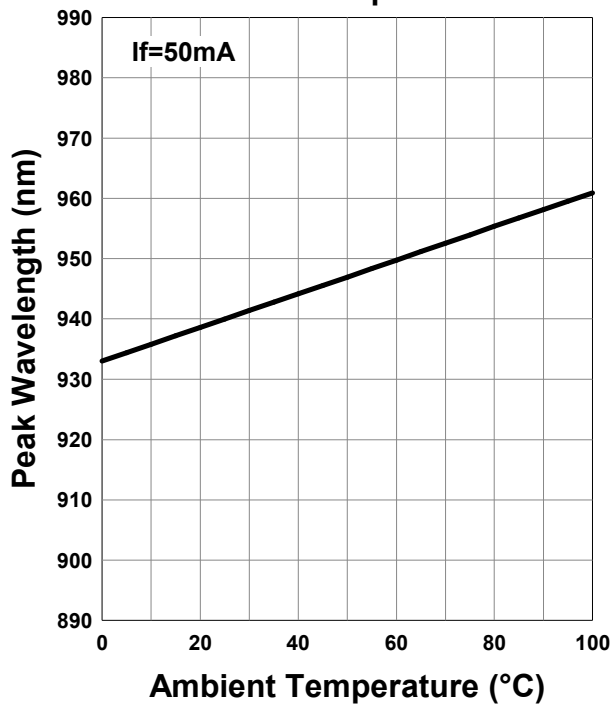

### Relative Spectral Emission

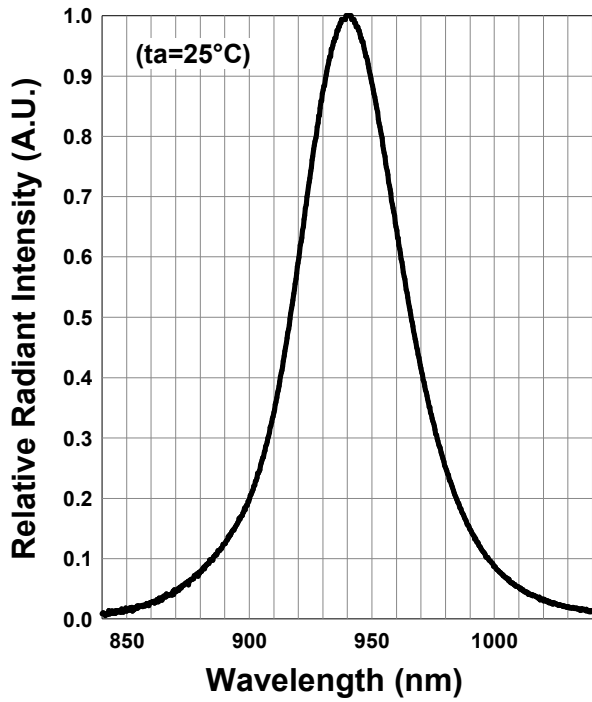

### Radiation Characteristics

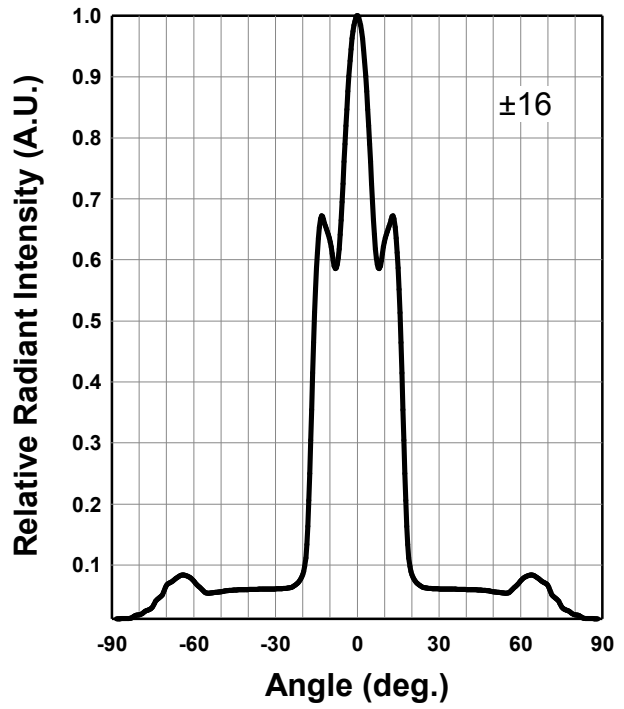

### Radiation Characteristics

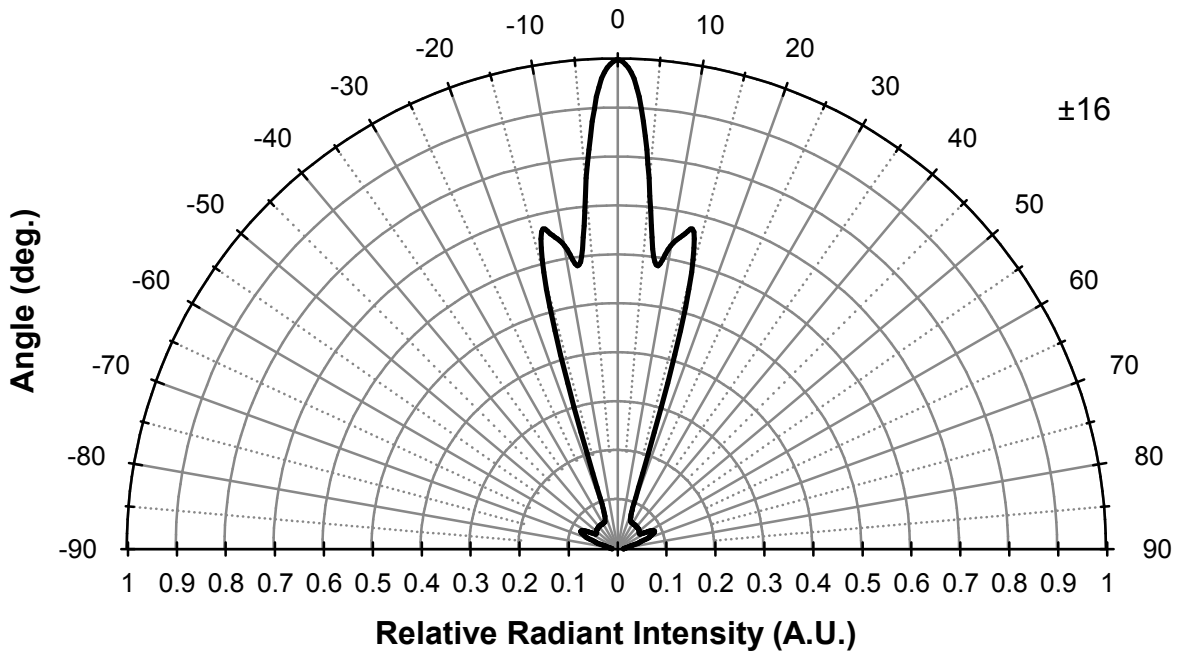

## Disclaimer

Product specifications and data shown in this product catalog are subject to change without notice for the purposes of improving product performance, reliability, design, or otherwise.

Product data and parameters in this catalog are typical values based on reasonably up-to-date measurements.

Product data and parameters may vary by user application and over time.

Products shown in this catalog are intended to be used for general electronic equipment. Products are not guaranteed for applications where product malfunction or failure may cause personal injury or death, including but not limited to life-supporting / saving devices, medical devices, safety devices, airplanes, aerospace equipment, automobiles, traffic control systems, and nuclear reactor control systems.

\*Effective July 2016, Ushio Epitex Inc. is now USHIO OPTO SEMICONDUCTORS, INC.